

Development of Control System for Fuel Metering Pump

Martin Švéda, Vladimír Hubík, István Szabó
UNIS, a.s. Jundrovská 33
624 00 Brno
Czech Republic
Email: {msveda, vhubik, iszabo}@unis.cz

Abstract—The aim of this article is to inform reader about the development steps and practices which were used during the development of a control system for a fuel metering pump. The aim of the development was to design a control system for a BLDC motor in accordance with rigid aviation standards and verify new development practices and tools allowing faster and more simpler certification. The development covers such steps as definition of first requirements, preliminary design, system modelling and simulation, detailed design, verification and testing. Given description introduces reader to mandatory practices and procedures which are obligatory for succesful certification of developed control systems. In addition, the first results measured on a evaluation sample are presented.

I. INTRODUCTION

Designed control system shall ensure safe and reliable control of a BLDC motor that drives the fuel metering pump (FMP). FMP operation shall be ensured at various external conditions, including harsh environments and unknown initial states as pressure in the system, position of the rotor or necessary starting torque of the BLDC motor.

A. Control system requirements

Requirements on the control system were defined at the early stage of the project and consulted with external specialists inside the CESAR project. These requirements include electrical characteristics, reaction of the control system on defined incidents, start-up characteristics, control commands etc. Most important requirements are listed below.

Interface characteristics

- The control system (CS) of the FMP should be controlled via a digital databus or a single analog signal.
- CS together with the BLDC motor should be supplied from A/C DC bus with possibile supply from a battery.
- CS should receive only start/stop and flow throttle commands.
- CS should be able to indicate the flow level, power bridge current, status word, FMP mode, Built-in-test results and start/stop command acknowledgements.
- The nominal power consumption should be less than 250W, the peak power consumption could be up to 500W for a defined period of time.

Functional requirements and performance characteristics

- CS shall ensure safe and soft start of the BLDC motor at any conditions.

- During operation the CS shall maintain the fuel flow at required values.
- CS shall enable internal parameters setting in a dedicated maintenance mode.
- CS shall be able to precisely meter flow of the fuel inside the defined interval.
- The maximum overshoot should be 5 % at $\Delta\omega > 40\%$ and the fuel flow should stabilize in 240 ms.

Physical requirements

- CS should be designed to reduce its overall dimensions and weight.
- CS fluid on air cooling system shall be designed to withstand ambient air temperature up to $+55^{\circ}C$.
- CS shall ensure normal non-degradated function under the defined circumstances and lifetime.
- Nominal operational temperatures shall be $-55^{\circ}C$ to $+85^{\circ}C$, short-time operating conditions shall be $-55^{\circ}C$ to $+125^{\circ}C$.

Beyond the above stated requirements, the control system and the FMP shall be designed in accordance with many other requirements regarding atmospheric pressure, temperature variations and humidity, shocks and vibrations, lightnings and electrostatic discharges.

For certification purposes the development, testing and verification must be performed in accordance with the aviation standards "RTCA/DO-178B – Software Considerations in Airborne Systems and Equipment Certification" [1], "RTCA/DO-254 – Design Assurance Guidance for Airborne Electronic Hardware" [2] and "RTCA/DO-160F – Environmental Conditions and Test Procedures for Airborne Equipment" [3].

Failure mode analysis (FMEA) of the designed hardware and testing of the SW code by means of dedicated tools are the mandatory parts of the development and both of these tasks were succesfully performed at the final stage of the development.

Compliance to the above mentioned aviation standards during the development was needed for demonstration of ability to design, develop and certify complex electronic control system for aviation industry, using new approaches based on utilization of COTS components and integrated simulation tools.

II. CONTROL SYSTEM MODELLING AND SIMULATIONS

Based on previous experience every development of a control system starts with definition of requirements and system modelling. A mathematical model describing all parts of the control system together with a system under control gives the developers an exact idea about system behaviour, reactions and ability to verify different control strategy and algorithms in the early stage of the development. In addition, the control system can be tested by means of hardware in the loop simulation, e.g. using tool such a dSPACE, completely without any previous hardware design. This is a considerable advantage since the team could precede many mistakes, dead ends and even damage of the first evaluation samples. Unquestionably, these are the benefits that considerably decrease the development time and costs.

The mathematical model of the control system with controlled BLDC motor consists of three basic parts: *electrical*, *mechanical* and *sensing*. The model was designed to implement as many as possible of the known motor parameters given by its producer and also as many parameters which describe the control system in the appropriate detail to closely match the real conditions. It is beyond the scope of this article to describe the whole mathematical model in detail; inquisite reader can find it in [4] or [5].

The important tracked values are amplitude of induced voltages in particular windings, winding currents, rotor position and acceleration of the rotor. An example of traced values is depicted in Figure 1.

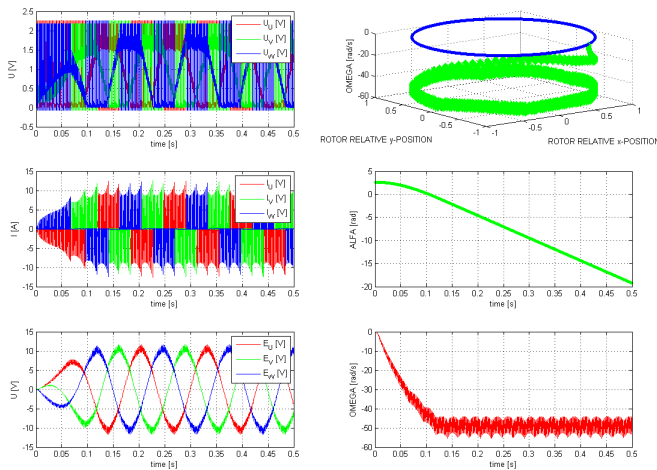

Fig. 1. Example of the CS simulation results

The starting phase of the rotor was chosen as the most important since this phase is the most critical during operation of the FMP. Therefore many algorithms were tested to achieve fast reaction and smooth acceleration at reasonable current flow level. Values provided by the simulations of the control system were used in the hardware design which was the next step of the project.

III. HW DESIGN OF THE CONTROL SYSTEM

The control system is designed as modular and it consists of three parts that can be interchangeable according to customer needs. The three basic modules are Control and Communication Unit (CCU), Power Electronics Unit (PEU) and I/O Unit (IOU). The control system architecture is shown in Figure 2.

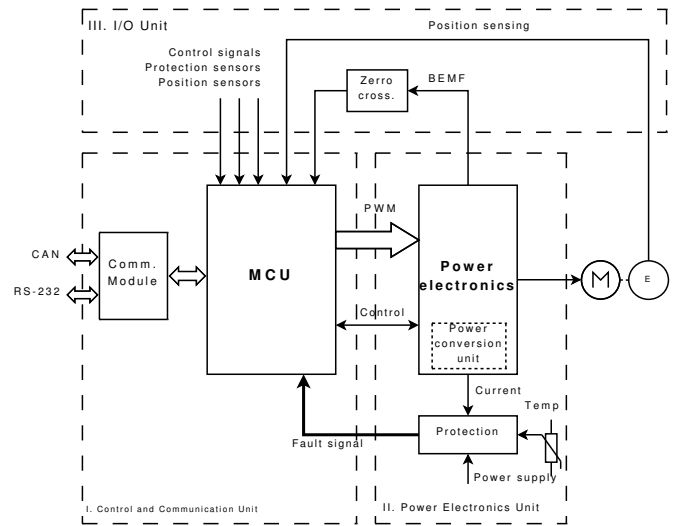

Fig. 2. Architecture of the electronic control system for EHA/EMA actuators

A. Control and Communication Unit

The main microcontroller is placed on the Control and Communication Unit (CCU). The CCU is replaceable according to application performance requirements and architecture of the control system. The core of CCU is created by a multipurpose microcontroller (MCU).

The CCU has a unified interface for all the analog and discrete signals that are used for control and communication with other control system modules. Using a unified interface enables replacement of the CCU in case of system enhancement or maintenance.

The electronic control system for the FMP can provide selected information of its internal states and measured values to the higher level control system via an internal communication network. The higher level control system can be a Flight Control Computer (FCC) or a multifunction avionic display placed in the pilot's cockpit.

B. Power Electronics Unit

The Power Electronics Unit (PEU) consists of full H-bridge that is created by six power switching transistors. Motion of the BLDC motor is controlled by switching power supply to the particular coils of the BLDC motor.

An integral part of the PEU is the Protection module that measures temperature, current and voltage on the BLDC motor. In case of any parameter exceeds a limit value the protection module generates a fault signal that enters into the MCU. Detection of the fault signal causes disconnecting of load from the power supply source.

C. I/O Unit

1) *BLDC motor signals/sensors*: Depending on actual configuration, the electronic control system could operate either in sensor or sensor-less mode.

In sensor mode signals from Hall sensors are used as feedback. These sensors are usually mounted inside the BLDC motor by its producer. These signals are triggered and used as inputs into the control MCU.

Sensor-less control mode operates on principle of sensing induced voltage caused by Back Electro Motive Force (BEMF) on one of three BLDC motor phases. Feedback is extracted by the means of BEMF and zero-cross detection.

Functionality and safe operation of the actuator is ensured by monitoring of selected parameters and restricting the actuator's fault operation. If one or more of the signals exceed its limit value, the fault is detected and appropriate action is taken.

D. Evaluation sample

The control system was designed to fit the requirement of mounting into the FMP to create a monolithic box with an explosion-proof design. The development run in accordance with the aviation standards RTCA/DO-254 [2] and RTCA/DO-160F [3].

The first evaluation sample is shown in Figure 3



Fig. 3. The first evaluation sample of the control system for FMP

Electronics of the control system is designed in a custom tailored shape with logical partitioning according to performed functions. Logical partitioning to control, power electronics and sensing board brings also the advantage of custom configuration and much simple service.

IV. CONTROL SYSTEM SOFTWARE DESIGN

The main aim, that was taken into consideration, is that control system had to be portable and easy to implement on a common 16-bit MCU. Final control system is written in the C programming language and is implemented into a Microchip dsPIC MCU.

Algorithms are designed with respect to high criticality of the application, therefore no artificial methods or fuzzy control algorithms could be used. Requirements on high reliability also limit the code complexity, thus simple but efficient software algorithms are used where ever it is possible.

Software design was preceded by detailed decomposition of system requirements, interface definitions, data flow and control flow. These requirements and definitions expressively determined final form of source code. Therefore their thorough evaluation was extremely important for design of control algorithms. Proper definition and evaluation simplified software development cycle and eliminated errors caused by further implementation of additional functions.

The control algorithm is designed according to the flowchart that is shown in Figure 4. The algorithm consists of initialization part, motor start-up, closed loop control and interrupt service routines.

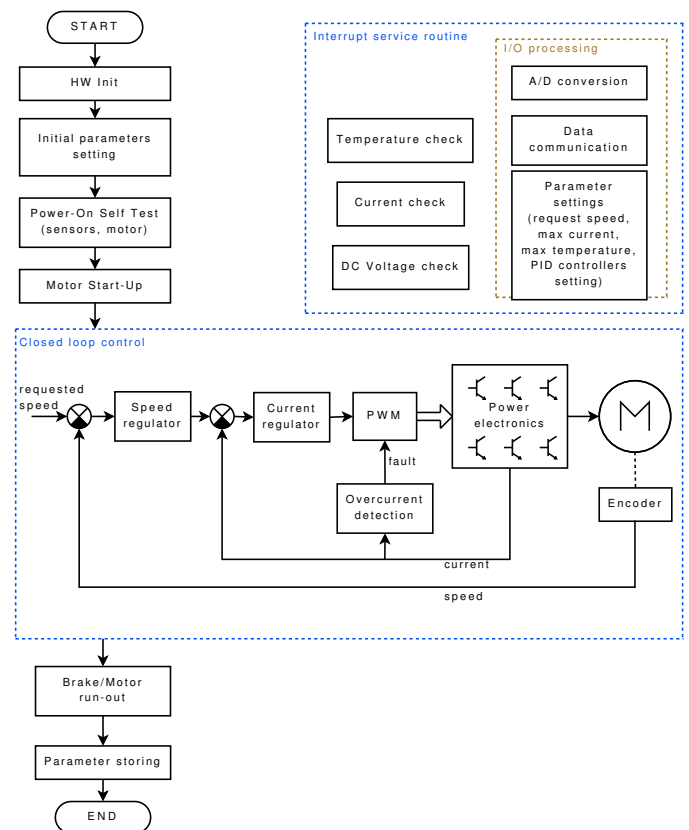

Fig. 4. Concept of the control system software design

A. Initialization

Initialization part serves for initial hardware set-up, parameter setting and power-on self test. During this stage all the parameters and values are checked against the standard values. In case of abnormal value or malfunction the control system issues warning and tries to re-initialize hardware again.

B. Motor start-up

In critical applications, it is necessary to ensure correct start-up of the motor. Thus, many simulations had been done before implementing the control algorithm into the controller. The motor start-up algorithm ensures reliable start-up of different types of BLDC motors.

C. Closed loop control

After initialization and motor start-up sequence, the control algorithm switches into the closed loop control. Closed loop control algorithms consist of the two nested PID controllers - the speed controller and the current controller.

The current regulator sets the desired value by means of PWM. It compares a desired value from superior speed regulator and measured current through the BLDC and sets output value upon their variance.

The speed regulator sets the desired value for the current controller. Actual rpm speed could be measured by Hall sensors or using a Back Electro-Motive Force (BEMF).

D. Interrupt service routines

Interrupt service routines serve for performing repeating tasks that evaluate critical values, such as power electronics temperature, current flowing into the BLDC motor, DC bus voltage, etc.

Separate interrupt service routines also serve for Input/Output processing and measurement. These especially involves:

- A/D conversion,
- data communication (via CAN or RS-232 data interface),
- parameter settings (parameter setting is based on data communication commands).

V. CONTROL SYSTEM TESTING AND EVALUATION

For testing and evaluation purposes an evaluation test bench were designed. This evaluation test bench had been designed with bearing in mind future applications concerning the development and testing of control electronics and software algorithms used for driving different BLDC motors within the voltage range up to 48V and power up to 1.5kW, which match both the industrial and aerospace applications.

The evaluation test bench can be divided into several parts – mechanical brake, electrical brake, test bench control system and graphical user interface. Individual part is connected to a common CAN databus to communicate amongs each other allowing distributed control, data collection and visualization of selected parameters. The evaluation test bench can be operated in two modes (fast- and slow-speed) depending on configuration a connection of the evaluated motor to the selected brake side. The evaluation test bench is shown in Figure 5. Several parts of the test bench are connected together by elastic couplings, which if necessary can be used to couple shafts of different diameters. Alignment of the tested motor and torque meter in the mechanical and electrical part is done by means of a height-adjustable central fixture, to which the tested motor is fastened.

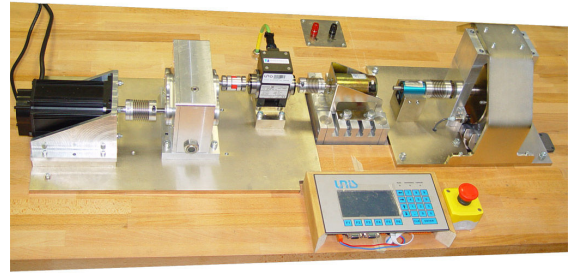

Fig. 5. The evaluation test bench

A. Electrical brake

The electrical brake side consists a torque meter with maximal 40 000 rpm and 2 Nm torque, a two-stage gearbox and a BLDC motor with a nominal power of 1 kW. The principle of the electrical brake side is similar to that of the active electric brake which produces the negative torque to the tested device. The braking torque can be continuously change and thus simulate dynamic load according to required specifications. Information about torque and angular speed are available from the torque meter in analog values that are converted to digital form and processed by the control system.

B. Mechanical brake

The mechanical brake side of the evaluation test bench consists of a torque meter with maximal 10 000 rpm and 10 Nm torque and a mechanical wheel-brake well known from the automotive industry. To enable continuous variable control of braking torque, the brake caliper is actuated by a special linear electric motor. The temperature of the wheel-brake disk is measured by a contactless infrared thermometer (pyrometer). Angular speed of the disk is sensed by an inductive sensor, which responds to movement of the disk's clamping screws. Analog information from the sensors is processed by the control system.

C. Control system and GUI

The control and display unit consists of a graphical monochromatic LCD display and the set of control buttons. The unit is connected to the common CAN databus and receives values to be displayed from the control system. The unit can send control commands to the control system, which takes appropriate actions. The basic displayed values are – torques from the both torque meters, angular speed, temperature of the wheel-disk brake, voltage and current generated by the electric motor in the electrical part of the test bench, etc. The basic parameters for setting are -, percentage of braking effect for the brake caliper, percentage of braking effect for the electric brake and e.g. limit value setting for the internal protection circuits.

VI. FIRST EVALUATION SAMPLE TEST RESULTS

To evaluate performance of the control system and designed electronics two types of evaluation test benches were used. Firstly, the in-house developed evaluation test bench described

in Section V. First measurements and simulated dynamic testing were performed on this evaluator; different control algorithms were tested and controller variables were set.

Then the control system electronics was mounted on the FMP and performance tests were performed on an evaluation mock-up platform that simulates a real fuel circuit. These tests were performed with help of an external company and the main interest were put on start and stop sequences of the FMP.

Start sequence of the FMP is shown in Figure 6.

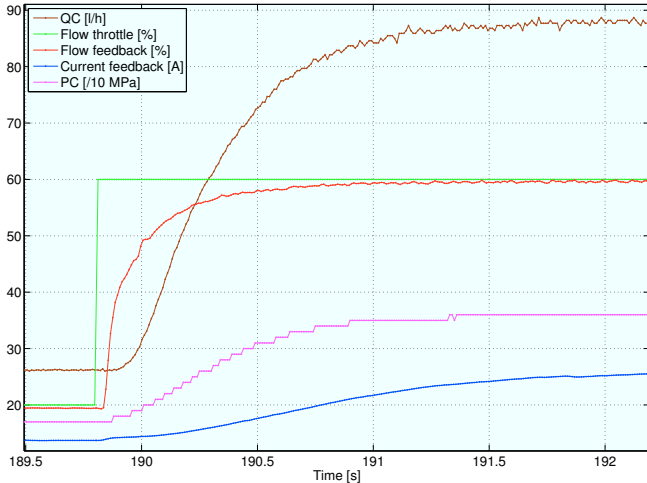

Fig. 6. FMP starting sequence measured on the fuel circuit simulator

In Figure 6 the green line represents the requested value of the fuel flow. The measurement monitors reaction of the system on setting the requested value of the fuel flow to 60 %.

The red line represents the fuel flow which is measured and computed by the control electronics. It is evident, that measured fuel flow gradually increases up to the requested value without overshoot.

The brown line indicates the real fuel flow in the system measured by an external sensor. Real value of the fuel flow traces the fuel flow measured by electronics with a slight time delay and slower increase which is due to physical characteristics of the mock-up system (gradual increase of fuel pressure, time delays caused by fuel flow through system).

The pink line represents pressure in the system and the blue line indicates peak current values during PWM cycle as were measured by electronics on the H-bridge.

Stop sequence of the FMP is shown in Figure 7.

In Figure 7 the color representation of individual measured values stays the same as in Figure 6. After setting the desired value of the fuel flow to zero, the control system of the FMP stops the BLDC motor and the fuel flow gradually decreases to zero. Stairly shape of the fuel flow (red line) measured by electronics is caused by overflow of the timer which is used for measurement of motor rpm. Fuel flow measured by the external sensor indicates gradual decrease although the BLDC motor is not running. This short term decrease of the fuel flow is due to inertial flow inside the mock-up system.

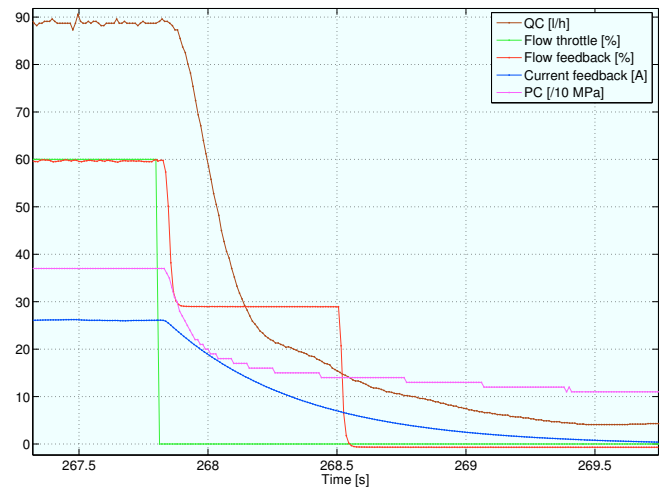

Fig. 7. FMP stopping sequence measured on the fuel circuit simulator

There is a noticeable slow current change in both Figures 6 and 7, which may have an effect on reader that the controller is not well optimized. But this slow changes result from given requirements and implementation of the controller which must assure exactly same time responses in a wide range of supply voltage (from 12 to 32 V DC). The controller is implemented as a two stage, with current controller and rpm controller in series.

But it is still obvious from both Figures 6 and 7 that the parameters of the controller are not set at the optimal values. Therefore the optimization of the controller's parameters was the next step in development.

A. Controller optimization

After the first steps were performed it became obvious that the controller is not optimally set. The requirements on overshoot was fulfilled but the reaction of the system was too slow.

First step in optimization of the controller was identification of the system. The system is represented by the BLDC motor with FMP and the hydraulic circuit. The system was identified by monitoring the reaction on a step-change of the PWM signal in open loop. Based on the reaction of the system on the step-change the system was identified and a mathematical model was designed.

The controller's parameters were investigated by means of MATLAB/Simulink tool using simulation of the system response on defined input signal and the optimal parameters were found by means of the least squares method. The optimal result for motor start-up is shown in Figure 8.

As is shown in Figure 8 the response of the system is now much faster, without overshoot and it nearly satisfies the first requirements. Nevertheless, the required response < 240ms still cannot be achieved because this requirement was due to time delays in the whole system rather unrealistic.

Performed simulation and testing showed promising results regarding the performance, reactions and power consumption.

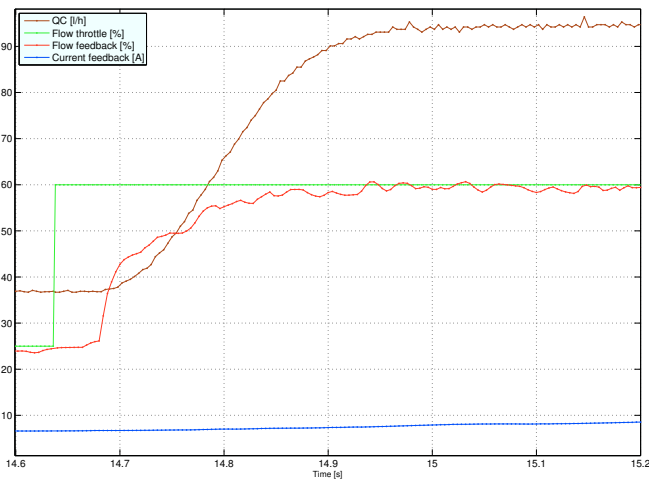

Fig. 8. Optimal motor start-up sequence measured on the fuel circuit imulator

Progression of measured values matches the expectations and desired characteristics. However, several improvements concerning the run-up algorithms were proposed and now they are under the development and testing. So far the results suggested yet significant reduction of power consumption, but suitability of new algorithms and BLDC motor control principles during the start-up phase must be proven by a long term testing.

VII. CONCLUSIONS

Development and certification of any device in aerospace industry requires comprehensive amount of effort, including definition of requirements, design of electronics, software coding and testing. In addition, very complex documentation must be maintained for the whole development and lifetime cycle.

Use of COTS components and development tools enables faster development cycle with ability of modelling and preliminary design in the early stage of project. Results from this stage can be used as a basis for hardware and software design which saves additional costs and accelerates the process very rapidly.

Development procedures described in this article indicates that they can bring significant improvements in performance, safety and reliability of the control system along with reduction of development time and costs.

ACKNOWLEDGMENT

Development of control systems for EHA/EMA actuators is supported by the European Union, FP6 IP research project No.: 30 888, "CESAR – Cost Effective Small Aircraft". Hardware and software development and physical modules were realized and project was supported by UNIS, a.s.

REFERENCES

- [1] *RTCA/DO-178B: Software Considerations in Airborne Systems and Equipment Certification*. RTCA, Inc.: USA, 1992.
- [2] *RTCA/DO-254: Design Assurance Guidance for Airborne Electronic Hardware*. FAA Advisory Circulars, AC No: 20-152, June 30, 2005.

- [3] *RTCA/DO-160F: Environmental Conditions and Test Procedures for Airborne Equipment*. RTCA, Inc.: USA, December 6, 2007.
- [4] HUBÍK, V.; ŠVÉDA, M.; SINGULE, V. *On the development of BLDC motor control run-up algorithms for aerospace application*. In Conference Proceedings. Poznan: 2008, pp. 1643–1647. ISBN: 978-1-4244-1742-1.
- [5] HUBÍK, V.; ŠVÉDA, M.; SINGULE, V. *Mathematical model of a sensorless BLDC motor for aerospace actuators*. In Modelling and Simulation MS 2008. Quebec City, Quebec, Canada: 2008, pp. 165–169. ISBN: 978-0-88986-741-3.